

Article number: 437900020

Description: Rota-fix shaft-hub connection SA 20

Measures

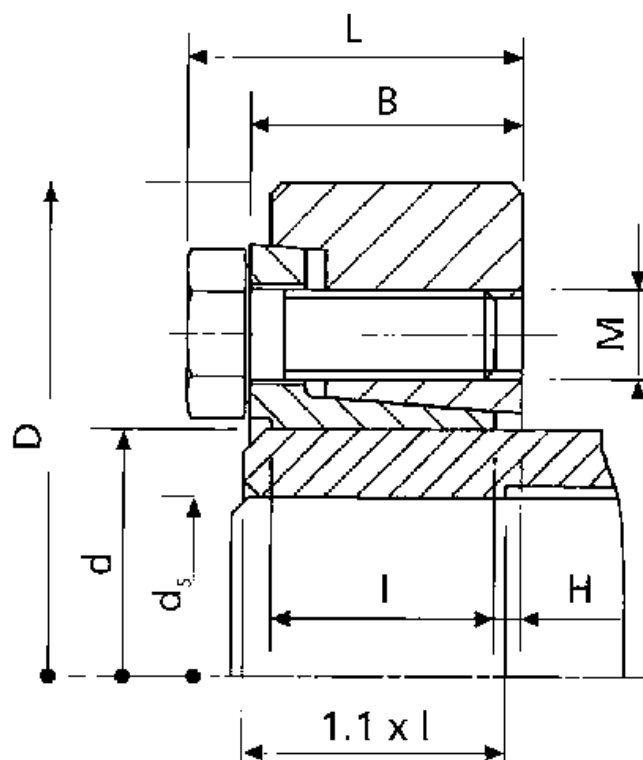

B mm	= 15.0	M mm	= M6
d H8 mm	= 20	T N m torque	= 150
D mm	= 47.0	Ts N m bolt tightening torque	= 13
ds mm	= 17		
F kN torque	= 18		
H	= 1.5		
I mm	= 12.5		
L mm	= 19.0		